

DE Montageanleitung

EN Mounting instruction

ES Instrucciones de instalación

FR Instructions d'installation

IT Istruzioni per l'installazione

NL Montagehandleiding

CS Návod k instalaci

PL Instrukcja montażu

RU Инструкция по монтажу

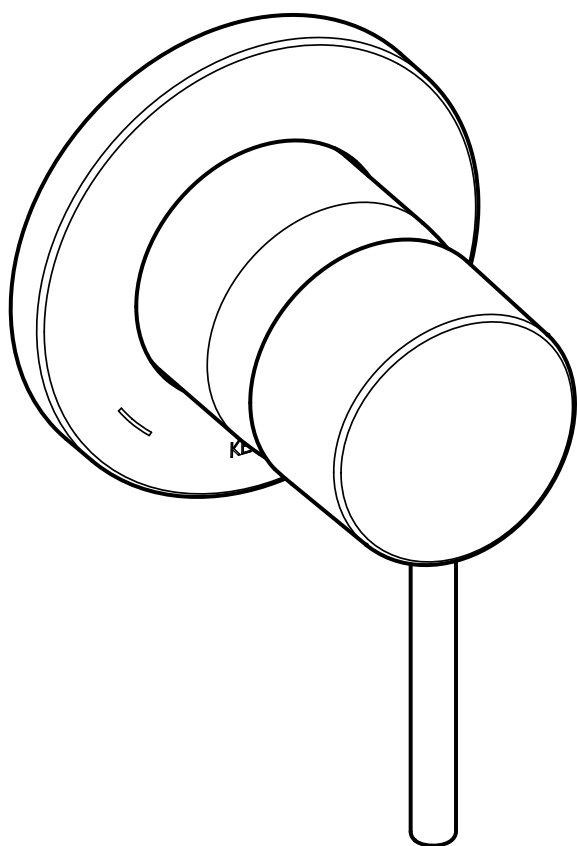

59551 010201
59551 370201

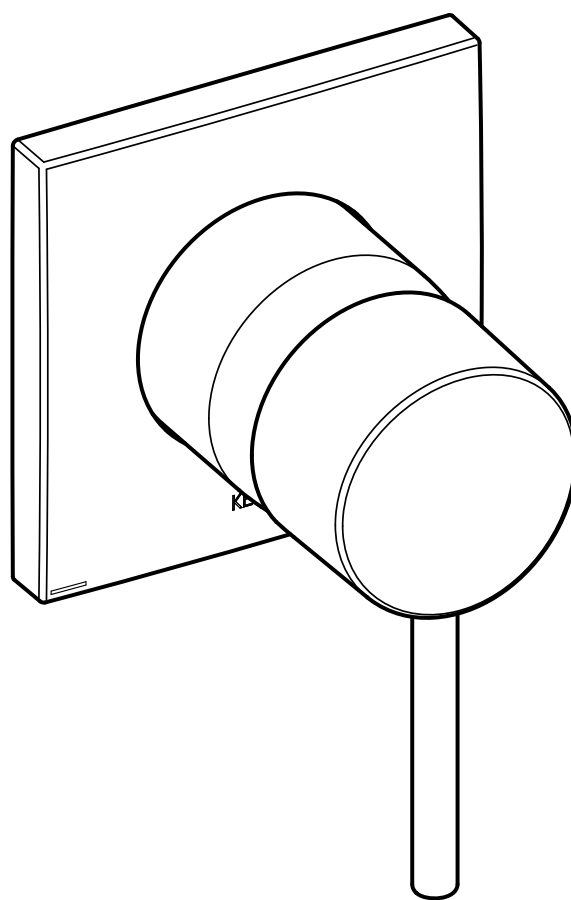

59551 010202
59551 370202

DE Einbaumaße

FR Cotes de montage

CS Montážní rozměry

EN Mounting dimensions

IT Ingombro

PL Wymiary montażowe

ES Dimensiones de montaje

NL Montageafmetingen

RU Монтажные размеры

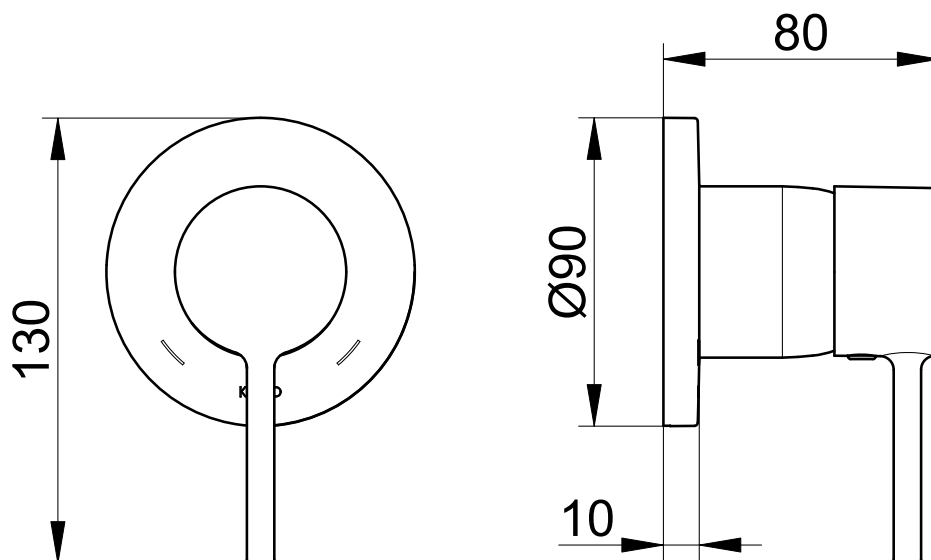

59551 XX0201

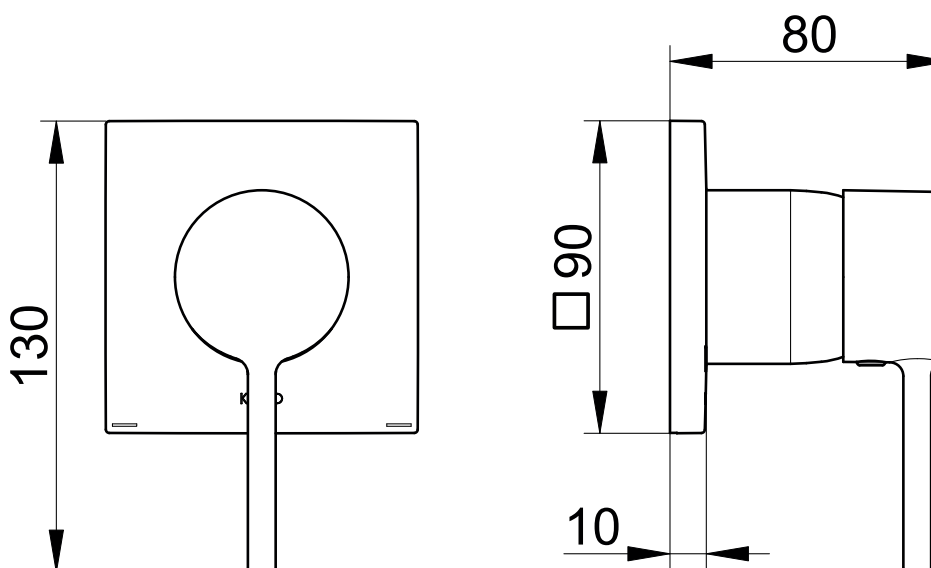











59551 XX0202











 Diese Anleitung ist für den Installateur zur Montage sowie für den Nutzer zur Bedienung und Wartung des Produktes. Bitte nach der Installation an den Nutzer zur Verwahrung weitergeben.

 These instructions are for both the installer for installation and the user for operation and maintenance of the product. After installation, please hand them over to the user to keep.

Symbole und Bedeutung

Symbols and explanations

-  **Achtung!** Warnung vor Personen- oder Sachschaden.
-  Hinweis, Tipp oder Verweis
-  Falsche Montage
-  Korrekte Montage/Funktionsprüfung
-  Montagedetail beachten
-  Kaltwasser  Warmwasser
-  Wasserfluss  Kein Wasserfluss
-  Optional/Zubehör

-  **Attention!** Warning against bodily injury or damage to property.
-  Note, tip or reference
-  Incorrect installation
-  Correct installation/test of functionality
-  Observe installation details
-  Cold water  Hot water
-  Water flow  No water flow
-  Optional/accessories

Verwendungszweck

Intended use

 Einhebelmischer für die Verwendung im Badezimmer.

 Single lever mixer tap for use in bathrooms.

Technische Daten

– Durchfluss bei 3 bar Fließdruck: ca. 23 l/min

Technical specifications

– Flow at 3 bar pressure: approx. 23 l/min

Einbaumaße, siehe Seite 2

Installation dimensions, refer to page 2

Installation, siehe ab Bild 1 auf Seite 8

Installation, refer to picture 1 on page 8

 Nur neutral vernetzendes Silikon verwenden.

 Use only neutrally netting silicone.

Bedienung, siehe Bild 8 auf Seite 9

Operation, refer to picture 8 on page 9

Temperatur- und Durchflussbegrenzung, siehe Bild 9 bis 11 auf Seite 9
Montage in umgekehrter Reihenfolge.

Temperature controll and flow rate limiter, refer to picture 9 to 11 on page 9
Assemble in reverse order.

Wartung, siehe Bild 12 auf Seite 9
Montage in umgekehrter Reihenfolge.
– Anzugsmoment Kartuschenmutter: 12-13 Nm

Servicing, refer to picture 12 on page 9
Assemble in reverse order.
– Cartridge nut torque: 12-13 Nm

Ersatzteile mit Bestellnummern, siehe Seite 11

For spare parts with order numbers, refer to page 11

 Hinweise zur Gewährleistung und Pflege sind dem beiliegendem **Pflege- und Garantiepass** zu entnehmen.

 For warranty and care information please refer to the attached **warranty and care instructions**.

 Este manual está dirigido al instalador para el montaje, así como al usuario para el manejo y mantenimiento del producto. Por favor, después de la instalación, este manual se debe entregar al usuario para que lo conserve.

Símbolos y significado

 ¡Atención! Advertencia de daños personales o materiales.

 Indicación, consejo o referencia

 Montaje erróneo

 Montaje/comprobación de funcionamiento correctos

 Observar el detalle de montaje

 Agua fría

 Agua caliente

 Flujo de agua

 Ningún flujo de agua

 Opcional/Acesorios

Uso previsto

 Mezclador monomando para la utilización en el baño.

Datos técnicos

– Paso con una presión de caudal de 3 bares:
aprox. 23 l/min.

Medidas de montaje, véase página 2

Instalación, véase imagen 1 en la página 8

 Utilizar exclusivamente silicona de reticulación neutra.

Manejo, véase imagen 8 en la página 9

Limitador de temperaturay y limitación de caudal, véase imágenes 9 a 11 en la página 9

El montaje se efectúa en el orden inverso.

Mantenimiento, véase imagen 12 en la página 9

El montaje se efectúa en el orden inverso.

– Par de apriete de la tuerca de fijación del cartucho: 12-13 Nm

Piezas de recambio con números de pedido, véase página 11

 En el pasaporte de mantenimiento y garantía adjunto encontrará indicaciones sobre la **manual de mantenimiento y tarjeta de garantía.**

 Ces instructions sont destinées à l'installateur, pour effectuer le montage, et pour l'utilisateur, pour utiliser le produit et procéder à sa maintenance. Après l'installation, veuillez remettre ces instructions à l'utilisateur pour qu'il les conserve.

Symboles et leur signification

 **Attention !** Mise en garde contre les dégâts de personnes et les dégâts matériels.

 Remarque, conseil ou renvoi

 Montage incorrect

 Montage correct/contrôle fonctionnel

 Respecter le détail de montage

 Eau froide

 Eau chaude

 Débit d'eau

 Pas de débit d'eau

 Option/accessoires

Domaine d'utilisation

 Mitigeur monocommande pour utilisation dans la salle de bains.

Caractéristiques techniques

– Débit à une pression d'écoulement de 3 bar :
env. 23 l/mn

Cotes de montage, voir page 2

Installation, voir figure 1 à la page 8

 N'utiliser que du silicone à réticulation neutre.

Utilisation, voir figure 8 à la page 9

Limiteur de température et limiteur de débit, voir figures 9 à 11, page 9

Le montage s'effectue dans l'ordre inverse de la dépose.

Maintenance, voir figure 12, page 9

Le montage s'effectue dans l'ordre inverse de la dépose.

– Couple de serrage écrou de cartouche :
12-13 Nm

Pièces de rechange avec numéros de commande, voir page 11

 Les consignes relatives à la garantie et à l'entretien figurent sur la **instructions d'entretien et carte de garantie** jointe.



Il presente manuale è indirizzato agli installatori per il montaggio nonché agli utilizzatori per l'uso e la manutenzione del prodotto. Consegnarlo all'utilizzatore dopo l'installazione affinché lo custodisca.

Simboli e significato

Attenzione! Pericolo di lesioni o danni materiali.



Avvertenza, consiglio o rimando



Montaggio errato



Montaggio corretto/verifica del funzionamento



Prestare attenzione al dettaglio di montaggio



Acqua fredda



Acqua calda



Flusso d'acqua



Nessun flusso d'acqua



Opzionale/accessorio

Scopo d'uso

Miscelatore monocomando per l'utilizzo in bagno.

Dati tecnici

– Portata con pressione di flusso di 3 bar:
circa 23 l/min

Ingombro, vedi pagina 2

Installazione, vedi dalla figura 1 a pagina 8



Utilizzare solo silicone neutro.

Uso, vedi figura 8 a pagina 9

Dischi di tenuta in ceramica limitatore di temperatura e limitazione di portata, vedi figura 9 - 11 a pagina 9

Eseguire il montaggio in ordine inverso.

Manutenzione, vedi figura 12 a pagina 9

Eseguire il montaggio in ordine inverso.

– Coppia del dado della cartuccia: 12-13 Nm

Ricambi con numero d'ordine, vedi pagina 11



Indicazioni relative alla garanzia e al trattamento vanno desunte dalle **istruzioni di manutenzione e certificato di garanzia**.



Deze handleiding is bestemd voor zowel de installateur voor de montage alsook voor de gebruiker voor het gebruik en het onderhoud van het product. Gelieve na de installatie door te geven aan de gebruiker om te bewaren.

Symbolen en betekenis

Opgepast! Gevaar voor letsel of schade.



Opmerking, tip of referentie



Verkeerde montage



Correcte montage/werkingstest



Montagedetails in acht nemen



Koud water



Heet water



Waterstroom



Geen waterstroom



Optioneel/toebehoren

Bestemd gebruik

Eenhendelmengkraan voor gebruik in badkamer.

Technische gegevens

– Doorstroming bij 3 bar stromingsdruk:
ca. 23 l/min

Montageafmetingen, zie pagina 2

Installatie, zie vanaf afbeelding 1 op pagina 8



Uitsluitend neutraal vernette siliconen gebruiken.

Gebruik, zie afbeelding 8 op pagina 9

Temperatuurbegrenzer en begrense waterdoorlaat, zie afbeelding 9 - 11 op pagina 9

Montage in omgekeerde volgorde.

Onderhoud, zie afbeelding 12 op pagina 9

Montage in omgekeerde volgorde.

– Aandraaimoment moer voor cartouche:

12-13 Nm









Reserveonderdelen met bestelnummers, zie pagina 11



Instructies voor de waarborg en het onderhoud vindt u in de meegeleverde **aanwijzingen voor het onderhoud en garantiebewijs**.

 Tento návod slouží instalatérům při montáži a uživatelům při obsluze a údržbě produktu. Po nainstalování ho předejte uživateli, aby si ho mohl uschovat.

Symbyoly a význam

-  **Pozor!** Výstraha před zraněním a věcnými škodami.
-  Upozornění, tip nebo odkaz
-  Nesprávná montáž
-  Správná montáž / kontrola funkčnosti
-  Při montáži dbejte na tento detail
-  Studená voda
-  Teplá voda
-  Průtok vody
-  Žádný průtok vody
-  Volitelná výbava / příslušenství

Účel použití

 Páková směšovací armatura pro použití v koupelnách.

Technické údaje

– Průtok při průtokovém tlaku 3 bary:
cca. 23 l/min

Montážní rozměry viz strana 2

Instalace viz obrázek 1 na straně 8

 Používejte pouze neutrální silikon.

Obsluha viz obrázek 8 na straně 9

Teplotní zářkou a průtok omezen viz snímky 9 - 11 na straně 9

Montáž probíhá v obráceném pořadí.

Údržba viz obrázek 12 na straně 9





Montáž probíhá v obráceném pořadí.
– Utahovací moment matice kartuše: 12-13 Nm

Náhradní díly s objednacími čísly viz strany 11

 Pokyny týkající se záruky a péče najdete v příloženém **Návodu k údržbě a záručním listu.**

 Instrukcja przeznaczona jest dla instalatora, zapewniając pomoc w zakresie montażu oraz dla użytkownika, informując go o sposobie obsługi i konserwacji produktu. Po instalacji należy przekazać instrukcję użytkownikowi, aby ją u siebie przechowywał.

Symbole i znaczenie

-  **Uwaga!** Ostrzeżenie przed szkodami osobowymi i materialnymi.
-  Informacja, dobra rada lub odsyłacz
-  Niewłaściwy montaż
-  Właściwy montaż / kontrola funkcjonowania
-  Należy stosować się do danych, dotyczących montażu
-  Woda zimna
-  Woda gorąca
-  Strumień wody
-  Brak strumienia wody
-  Opcje / Osprzęt

Przeznaczenie

 Bateria jednocywilowa do stosowania w łazience.

Dane techniczne

– Przepływ w przypadku ciśnienia hydraulicznego 3 bar: około 23 l/min

Wymiary zabudowy, patrz strona 2

Instalacja, patrz rys. 1 na stronie 8

 Należy wykorzystywać wyłącznie silikon, ulegający naturalnemu usieciowaniu.

Obsługa, patrz rys. 8 na stronie 9

Kontroli temperatury i ograniczenie przepływu, patrz rys. 9 do 11 na stronie 9

Montaż w odwrotnej kolejności.

Konserwacja, patrz rys. 12 na stronie 9

Montaż w odwrotnej kolejności.
– Moment obrotowy dokręcenia nakrętki głowicy: 12-13 Nm

Części zamienne z numerami zamówienia, patrz strona 11

 Informacje dotyczące gwarancji dostępne są w dołączonej **karcie pielęgnacyjno-gwarancyjnej.**



Данная инструкция содержит указания по монтажу изделия для слесаря-сантехника и указания по эксплуатации и техническому обслуживанию изделия для пользователя. После установки передайте инструкцию пользователю.

Символы и их значение



Внимание! Опасность физического и материального ущерба.



Указание, совет или ссылка



Неправильный монтаж



Правильный монтаж / проверка работоспособности



Важная информация по монтажу



Холодная вода



Горячая вода



Водный поток



Нет водного потока



Опция/принадлежность

Назначение



Однорычажный смеситель для использования в ванной комнате.

Технические характеристики

– Пропускная способность при давлении потока в 3 бар: около 23 л/мин

Монтажные размеры, см. стр. 2

Установка, см. рис. 1 на стр. 8



Использовать только силикон нейтрального сшивания.

Эксплуатация, см. рис. 8 на стр. 9

Поток ограничен и подсоединение для шланга, см. Рисунок 9 до 11 на стр. 9

Монтаж производится в обратной последовательности.

Техническое обслуживание, см. рис. 12 на стр. 9

Монтаж производится в обратной последовательности.

– Момент затяжки гайки картриджа: 12-13 Нм

Запасные части с номерами для заказа, см. стр. 11



Информацию о гарантии и указания по уходу см. в прилагаемом паспорте по уходу и гарантийному обслуживанию.

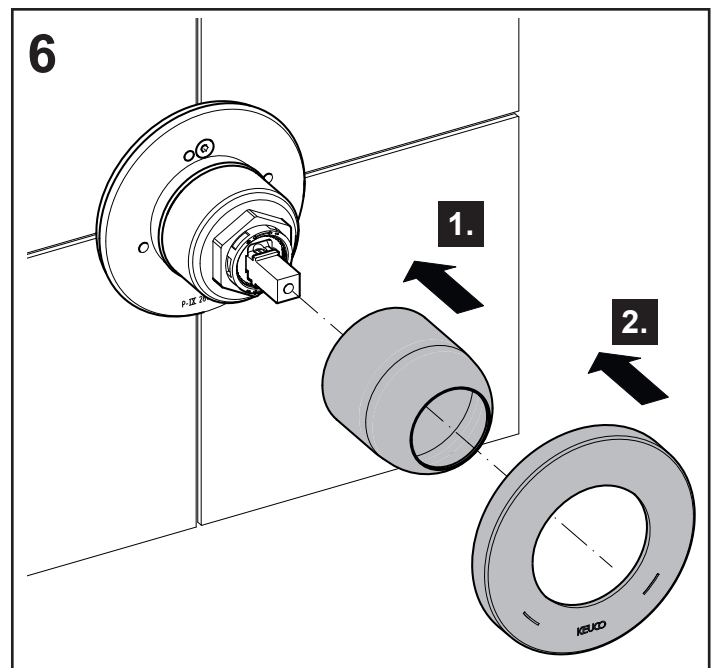
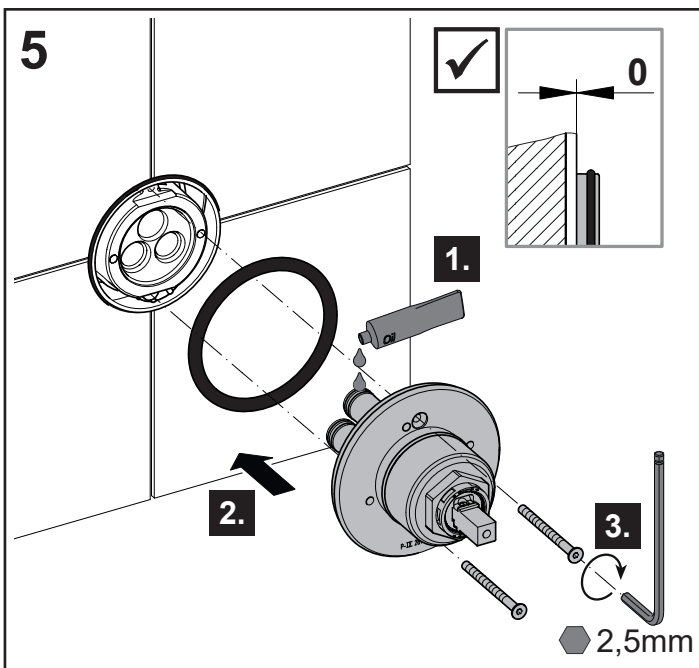
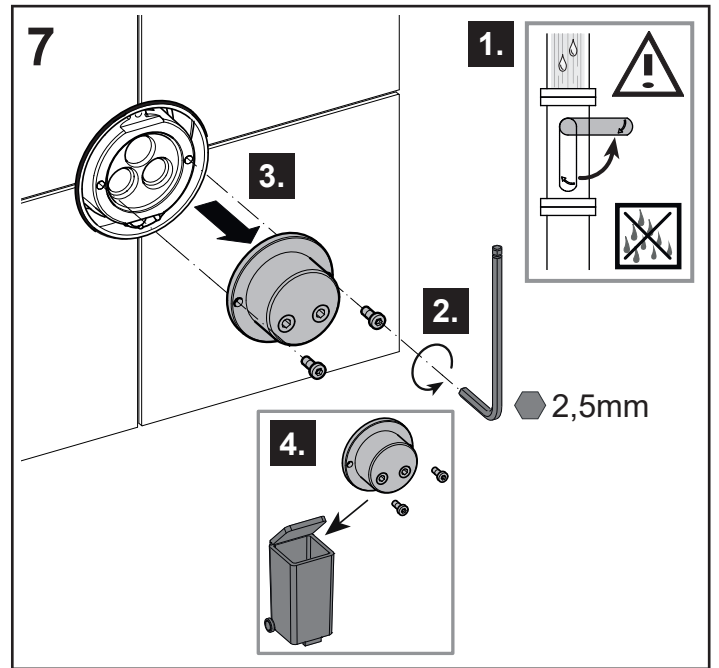
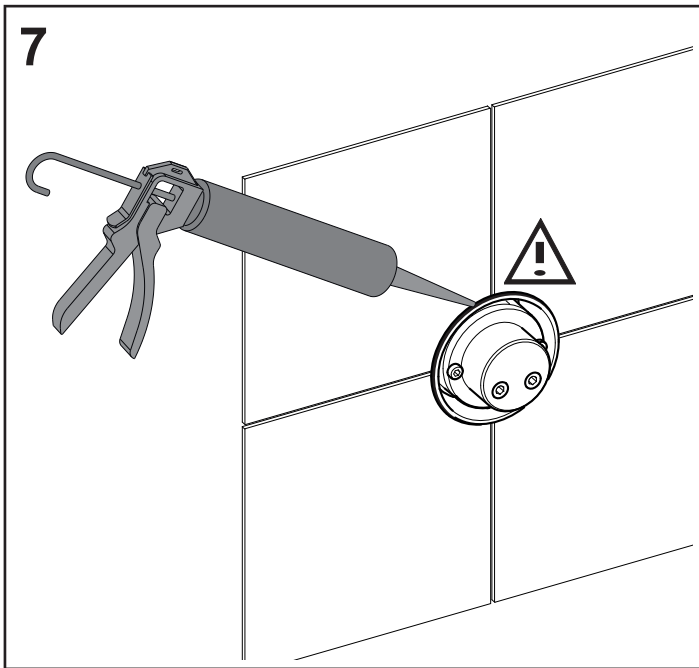
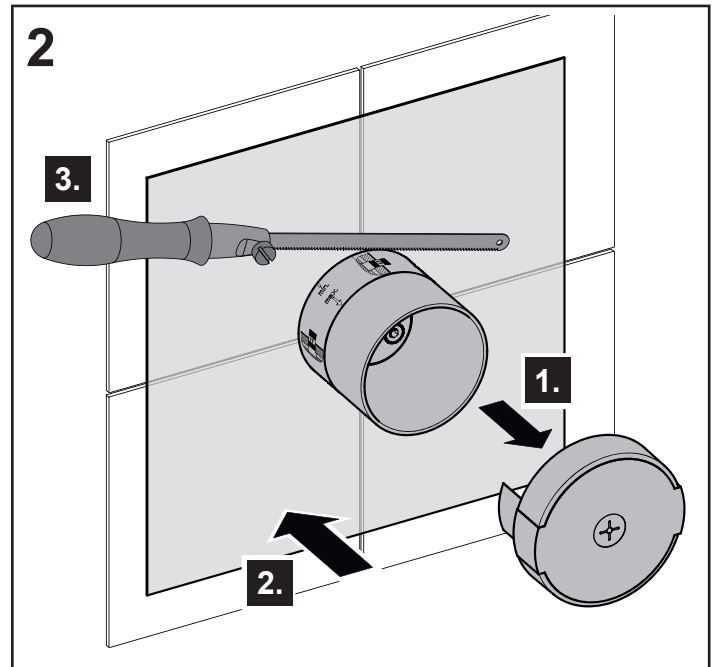
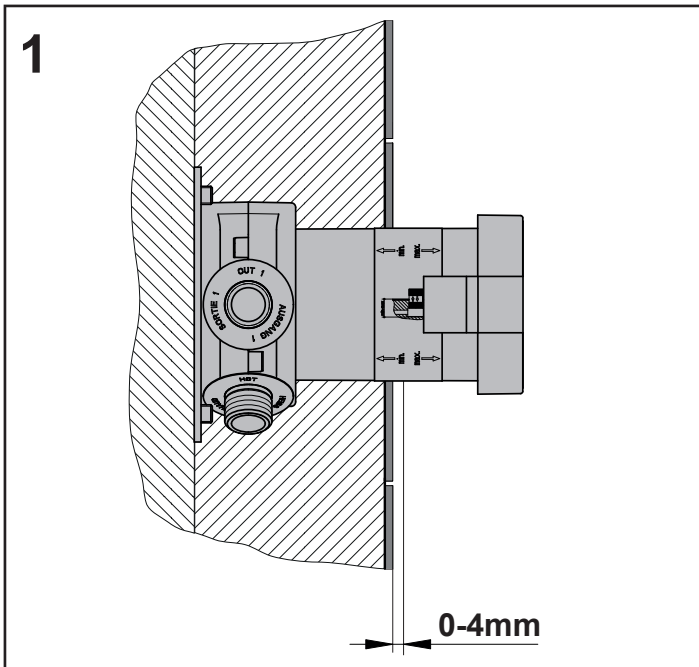

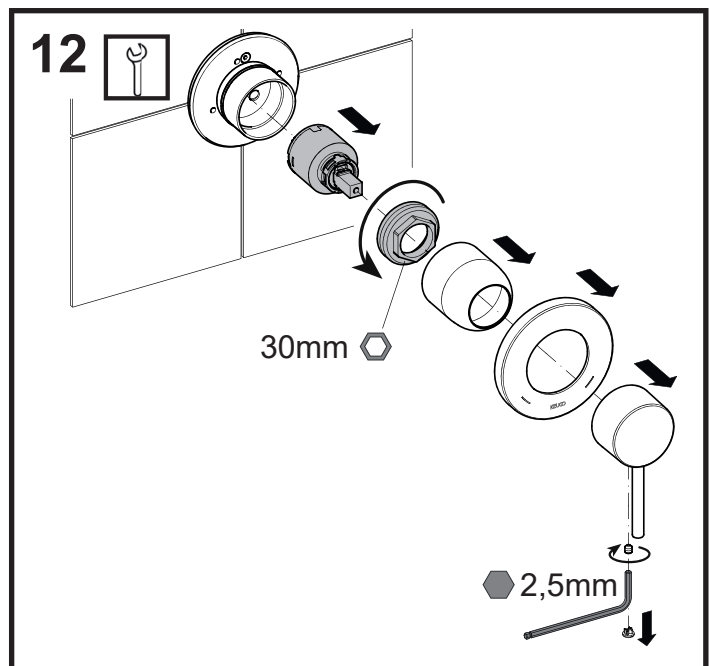
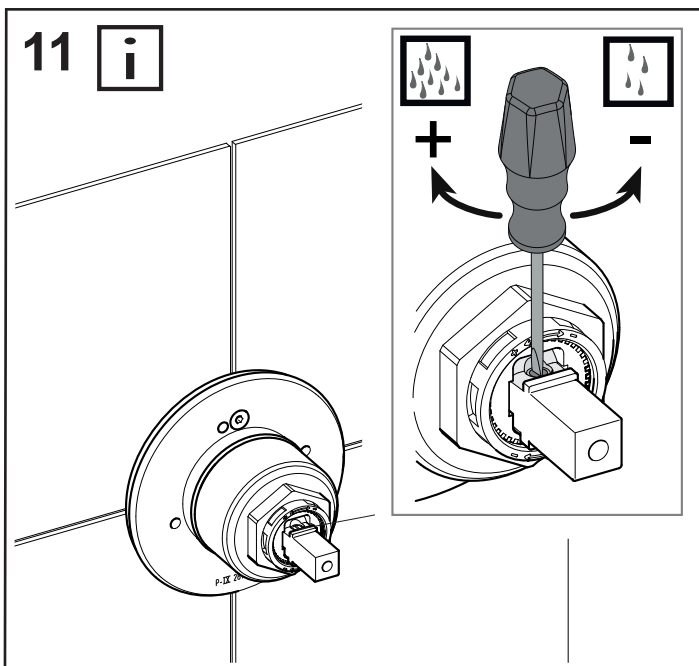
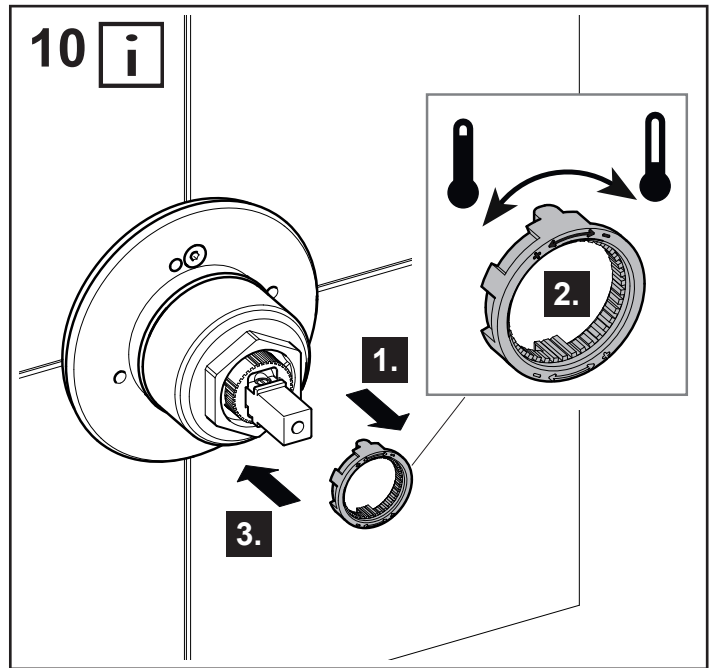
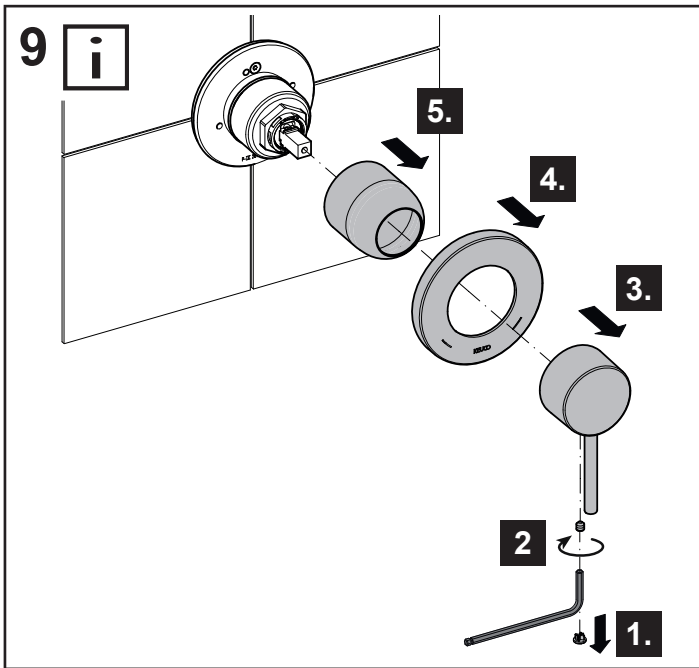
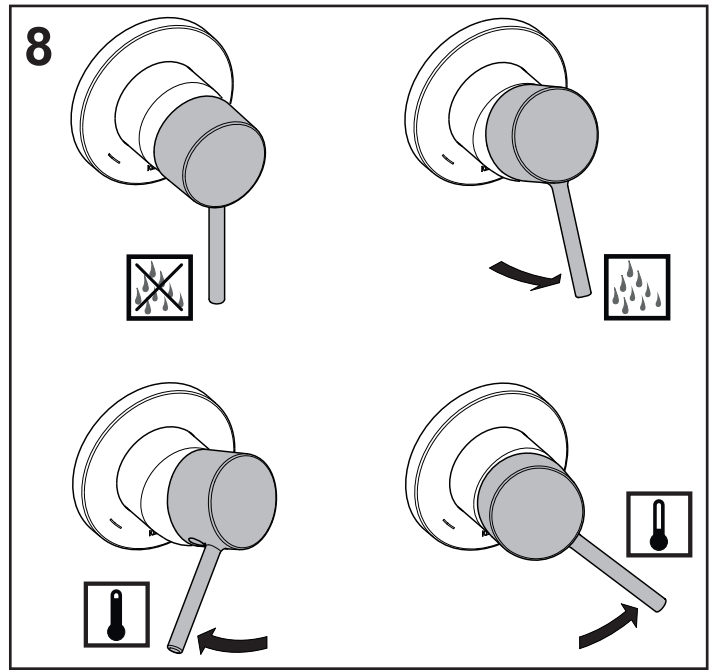
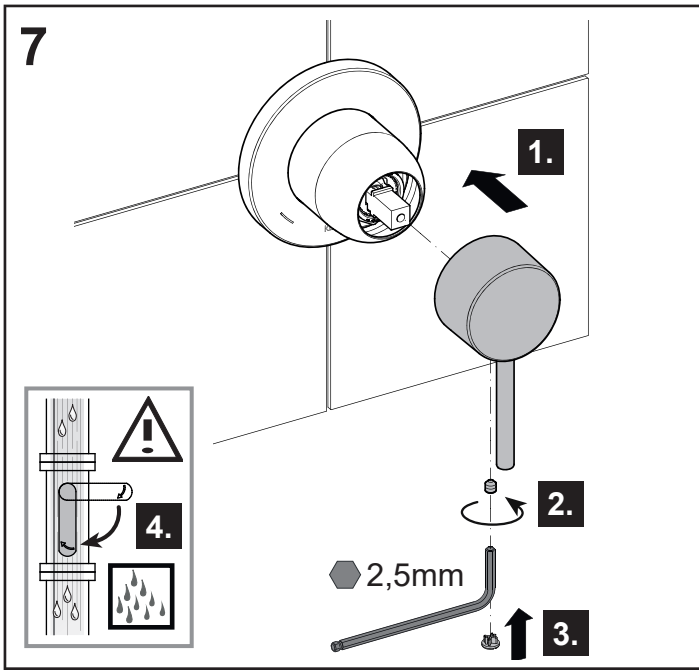



A series of 20 horizontal lines spanning the width of the page, providing a template for handwriting practice.

DE Ersatzteile

FR Pièces de rechange

CS Náhradní díly

EN Spare parts

IT Ricambi

PL Części zamienne

ES Piezas de recambio

NL Reserveonderdelen

RU Запчасти

59551 XX0201 59551 XX0202

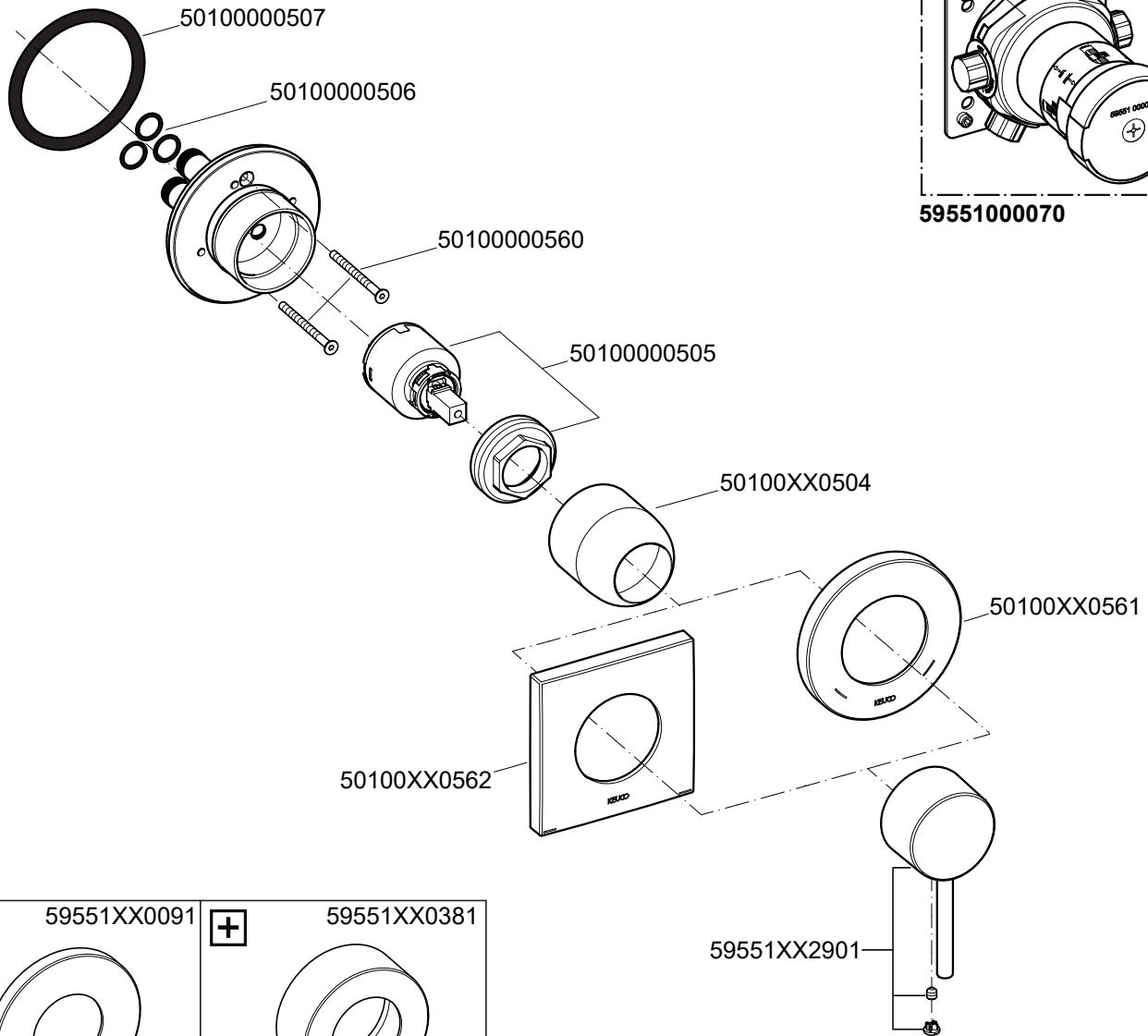

+ 59551XX0091



+ 59551XX0381

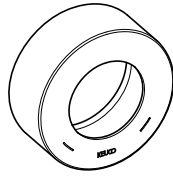

+ 59551XX0092

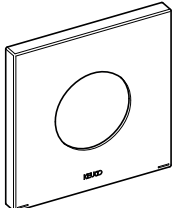

+ 59551XX0382

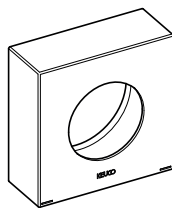

+ 59551000071

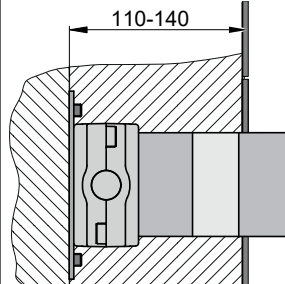
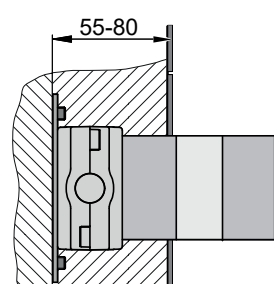
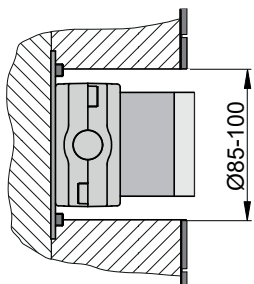

XX = 01, 37

